



Manufactured in the UK
Supporting the Economy

Nova SM

Twin wall, insulated
stainless steel
multi-fuel
chimney system

Also suitable for fully condensing appliances

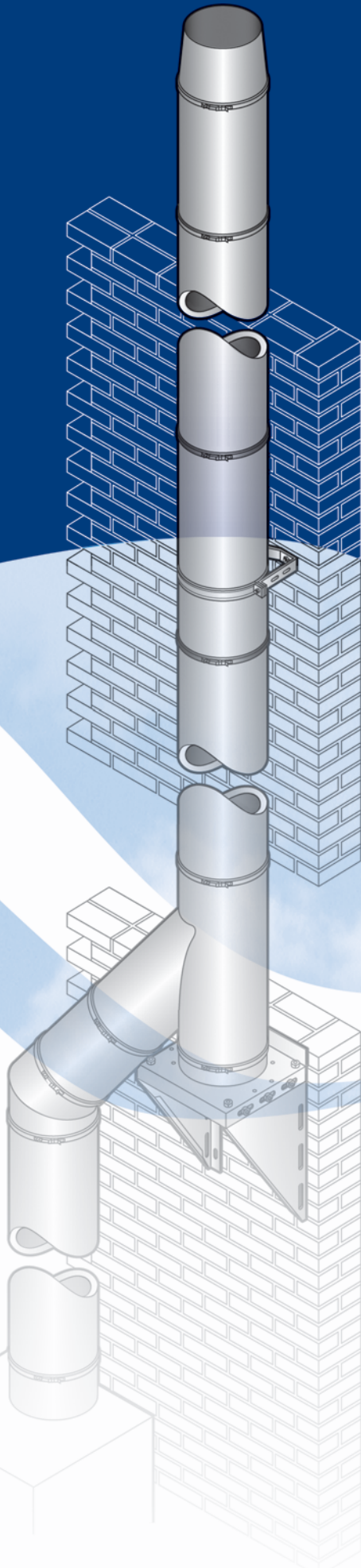

The Nova SM chimney system range is specifically designed to meet the demands of the latest high efficiency heating appliances as well as traditional gas, oil and multi-fuel combustion equipment, offering a one solution product for today's market.



Introduction

The Nova family of product has been specifically designed to meet the requirements for multi-functional applications serving a variety of fuels. Whether serving a traditional negative draught appliance or a modern high efficiency condensing appliance, the Nova SM product offers the ideal solution. With a wide range of components together with a multi-barb quick lock jointing system, Nova SM offers the ultimate in ease of installation, quality and functionality. Nova SM is a CE approved product and has been independently tested to the requirements of BS EN 1856-1, see Table 1 - Chimney designation.

Description

Nova SM is a prefabricated, factory made twin-wall insulated stainless steel system chimney. The fully welded construction combined with a high performance / high density insulating medium, provides the optimum level of performance required for today's modern high efficiency combustion equipment, as well as being suitable for the more traditional oil, gas and solid fuel fired appliance. The construction provides a high thermal resistance which ensures rapid stabilisation of the flue gas temperature and draught, whilst maintaining a relatively low temperature on the external surface of the chimney. Nova SM is designed for internal and external applications and is suitable for negative pressure applications. When used with a seal and where the flue gas temperature does not exceed 200°C, the Nova SM product is suitable for wet and positive pressure applications up to 200Pa (P1).

Nova SM utilises a multi-barb quick lock jointing system to secure each joint. The number of barbs depends on the product diameter, and in each case the components are secured by locating the barbs with a twist of each section. A locking band must then be used at each joint. The joint design facilitates a maximum unsupported height above the last support of up to 3.0 metres (2.0 metres for 100ID), subject to the design considerations detailed within the Installation Instructions and on page 19 of this brochure.

Nova SM is manufactured from a high grade 316L (1.4404 : X2CrNiMo 17-12-2) stainless steel liner and a 304 (1.4301 : X5CrNiMo 18-10-2) outer case. The product utilises a high performance mineral wool which is auger filled into a 25mm annulus between the inner and outer, offering rapid stabilisation of draught and excellent thermal performance. The unique joint design, allows the inner liner to freely expand and contract throughout the system as the flue gas temperature varies, alleviating the need for additional expansion components.

Application

The Nova SM product is available in 8 internal diameters ranging from 100mm to 355mm and is suitable for oil, gas, and solid fuel applications operating under negative draught / dry conditions or where the maximum positive pressure will not exceed 40Pa as designated by N1, at a maximum flue gas temperature of 450°C. Where used for solid fuel and oil applications where the flue gas temperature is greater than 250°C, the ventilated support components must be used as detailed on page 10.

For condensing (WET) / positive pressure applications, where the flue gas temperature will not exceed 200°C at a maximum positive pressure of 200Pa (P1), an optional seal can be fitted to the Nova SM product as detailed on page 3.

For condensing applications it is important that any sloping runs are angled not less than 3° where head room is an issue or preferably 5° from the horizontal. Drainage components should also be incorporated into the system to allow condensate removal to a suitable drain or gully. Tees and elbows are provided within the Nova SM range to facilitate a 3° or 5° incline from the horizontal.

Table 1 - Chimney designation to BS EN 1856-1

Nova SM product designations to BS EN 1856-1							
0086-CPD-496040	Nova SM	BS EN 1856-1	T450	N1	D	V2	L50050 G(50)
0086-CPD-496040	Nova SM	BS EN 1856-1	T200	P1	W	V2	L50050 O(50)
Standard number							
Temperature class							
Pressure class							
Condense resistance D=dry W=wet							
Corrosion class							
Material specification Liner grade 316L Liner thickness: 0.5mm							
Sootfire resistance G=yes O=no							

Note: P1 rating requires seals fitted to the Nova SM product

Lateral supports

Wall bands are available for the lateral support of the installation. These are available in both galvanised steel and stainless steel for external applications. All wall bands offer 50mm clearance from the outer case of the flue. Optional extension brackets are available to increase this distance up to a maximum of 100mm, see page 11.

Roof support

A rafter support bracket is available where the flue section passes through the roof to termination. This component offers both lateral and vertical loading. Full support data can be found on page 16 or in the Installation Instructions.

Joint design and construction

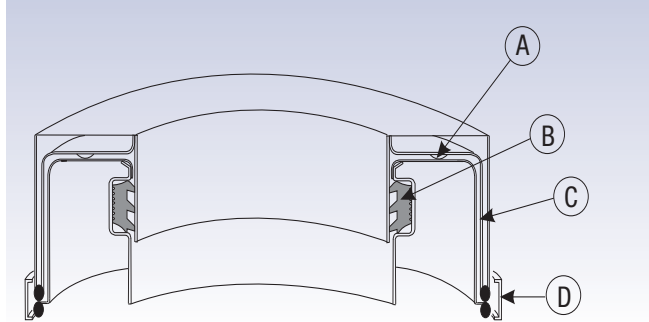

A – Coupler separator

The coupler separator is a 1mm dimple which is designed to allow a controlled amount of air to pass across the coupler interface. This limits thermal bridging and heat transfer across the joint as well as reducing the potential for capillary moisture movement.

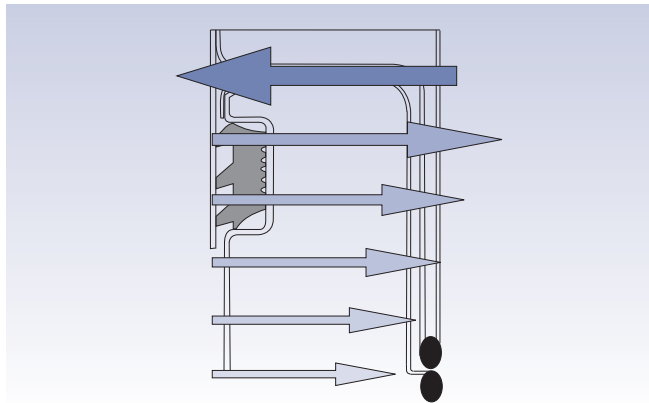

B – Retrofit seal

The Nova SM product offers a retrofit seal that can be fitted around the inner groove as shown above. The seal facilitates positive pressure and condensate resistance up to 200Pa at a maximum flue gas temperature of 200°C, offering a P1 rating to BS EN 1856-1. For higher pressure capability, please refer to SFL Technical Department.

C – Quick lock jointing system

The Nova SM joint incorporates a sixteen barb* twist lock coupler system to allow easy and rapid installation of the product. When used with the Nova SM support components the joint will support up to 3.0 metres free standing above the last support, see Installation Instructions or page 19 for further details.

* 100 internal diameter has 8 barbs and has a free standing capability of 2.0 metres, subject to design guidance.

D – Locking band

The locking band is used to complete the joint and incorporates a simple fixing mechanism to facilitate speed and ease of installation.

Joint assembly

The joint is made by fitting the female end over the male end and engaging the joint system by rotating the component clockwise. A locking band is then fitted to finalise the joint, as detailed below.

Fig. 1

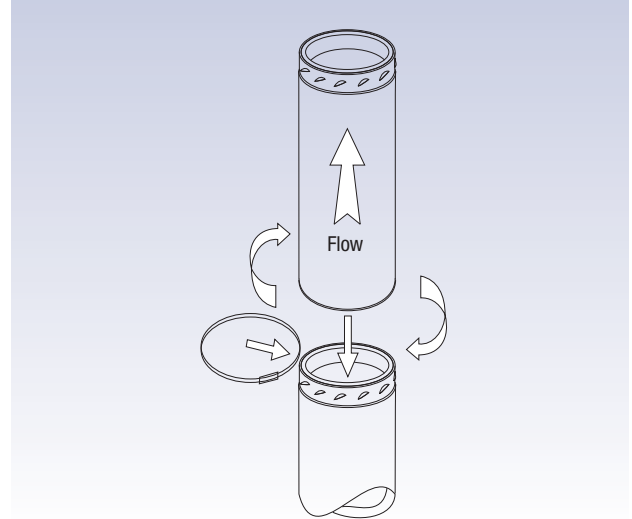

Approvals

The Nova SM product has been assessed and CE marked to BS EN 1856-1 to the performance designations as detailed on page 2, table 1.

Nova SM has also been assessed by the Loss Prevention Council for fire resistance. A fire resistance of two hours can be achieved in accordance with the stability and integrity criteria of BS 476: Part 20 for duct type B.

Quality

All components are manufactured under a quality assurance scheme, certificate No. FM557622, administered by British Standards in accordance with BS EN 9001: 2008. In addition SFL operate a CE approved factory production control system as required under the Construction Products Directive 93/68/EEC.

Installation regulations

Where the flue passes through combustible floors it is important that the correct firestop components are used and the correct distance to combustible materials is observed as detailed in the Nova SM Installation Instructions.

All firestop and support components within the Nova SM range are designed to offer a minimum clearance to combustible material of 50mm. In all instances the requirements of the building regulations must be complied with and the appropriate references are: Document J of the DOE Building Regulations, Section F of the Building Standards (Scotland), Section L of the Building Regulations (Northern Ireland). Reference should also be made to the relevant British and European Standards governing the installation of flue and chimney products for the associated fuel and appliance types as detailed:

- *Solid Fuel and Oil Fired Applications: BS EN 15287: 2007*
- *Domestic Gas Installations up to 60kW: BS5440: Part 1: 2008*
- *Commercial Gas Installation up to 70kW and 1.8MW (net), the installation should conform to BS 6644:2005*

For further information, please refer to installation instructions commencing on page 16.

Note: In the UK, connection to an appliance which is not connected to a fuel supply, may be carried out by a competent person. However connection to an appliance that is connected to a fuel supply must be carried out by an approved and registered heating engineer, e.g. Gas Safe(Gas) or OFTEC (Oil). For other European countries, reference should be made to EN 15287: Part 1: 2007: Chimney – Execution standard for metal chimneys. The National Annex NA of EN 15287 should detail the national regulatory requirements for that particular country.

Components

The Nova SM product offers a complete range of prefabricated components allowing complete flexibility to meet today's demanding applications. Installed lengths of 1000mm, 500mm, 250mm and 120mm are available, together with adjustable lengths. A variety of tees, elbows, supports, fixings and firestop components are available as standard throughout the diameter range.

Those components within the range that are manufactured from only single skin, can be vulnerable when exposed to the products of combustion from solid fuel appliances. This is especially true for terminals, however in the majority of cases, an open-ended terminal better suits appliance performance, but it is acknowledged that on occasions, other types of terminal from the range have to be used to reduce rain entry. Condensate collectors and locking plug when used on solid fuel are also vulnerable to flue gas by-products, particularly if the chimney is not regularly maintained and cleaned. Such components are considered sacrificial and their life expectancy will vary depending on application, location, maintenance and fuel usage. For this reason, these items are only covered by a twelve month guarantee and not the standard 15 year conditional manufacturing defects guarantee.

Life Expectancy and affecting factors

The Nova SM product is manufactured to the highest standard, tested in accordance with EN 1856-1. Under normal operating conditions Nova SM should provide many years service and is provided with a 15 year conditional manufacturing defect warranty. However careful consideration of the following points must be observed to limit the risk of chemical corrosion to the product.

Chemical contamination of combustion air

Under no circumstances should an appliance be located where there is the potential of chemical contamination of the combustion air. Typical examples are de-greasing plants, dry cleaning agents and chemical cleaning products.

Chemical chimney cleaning products

Under no circumstances should chemical chimney cleaning products be used. Only traditional sweeping of the chimney should be employed.

Use only approved solid fuels

Where used on solid fuel, care should be taken to ensure that only high quality fuel is used. SFL do not recommend fuels such as petroleum coke or other fuels containing a blend of petroleum coke. Also some smokeless fuels contain halogens that are released when burnt, forming Hydrochloric and Hydrofluoric Acids. These fuels can lead to premature failure of the chimney system through corrosion. Before burning any fuel, SFL would suggest that written confirmation is obtained to ensure that the fuel is halogen free. Only HETAS Approved solid fuels should be used with SFL products.

It is also important that when burning wood that it has been properly treated and free of any potential chemicals such as preservatives, insecticides or treatments. Freshly cut firewood can contain up to 50% moisture, provision must be made to allow the wood to season so that the moisture content is reduced to around 20%. This must be done in a dry environment and can take up to 8 months. Green wood can lead to products like creosote being deposited on the chimney liner and could lead to a chimney fire occurring or premature corrosion / failure of the liner.

Biofuels

Nova SM is suitable for pellet and wood chip biofuel applications; however other forms of biofuel when burnt can produce aggressive and corrosive acids which can lead to premature failure of stainless steel components. Written confirmation should be obtained from SFL prior to installing Nova SM on other types of biofuel.

Coastal locations

It is advised where the chimney is exposed to severe coastal locations that suitable external protection should also be applied to the outer case of the product. This could be achieved using a specialist protective coating or by having the product professionally painted. It is recommended that only stainless steel components are used for external applications, however where galvanised components are used, they should be adequately protected using an appropriate coating.

Typical installation serving condensing appliances

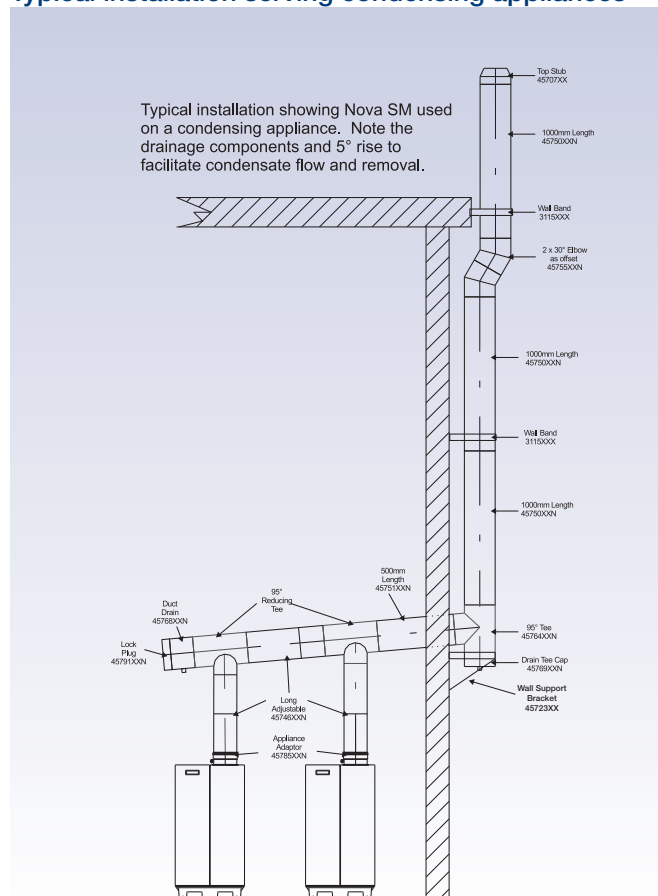

Calculation and technical support

Using the latest software modelling, SFL can undertake full chimney sizing calculations to BS EN 13384 Parts 1 & 2 as well as advise on other technical matters regarding the Clean Air Act and current regulations regarding chimney systems.

Lengths

Straight lengths

Straight lengths are available in nominal installed lengths of 1000mm, 500mm, 250mm and 120mm.

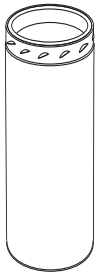

Size	Nova SM code numbers			
	1000mm	500mm	250mm	120mm
100mm	4575004N	4575104N	4571904N	4575304N
130mm	4575005N	4575105N	4571905N	4575305N
150mm	4575006N	4575106N	4571906N	4575306N
180mm	4575007N	4575107N	4571907N	4575307N
200mm	4575008N	4575108N	4571908N	4575308N
250mm	4575010N	4575110N	4571910N	4575310N
304mm	4575012N	4575112N	4571912N	4575312N
355mm	4575014N	4575114N	4571914N	4575314N

Starter Length

Designed to offer an aesthetic transition between the single wall flue pipe and the Nova SM chimney system. Also available in satin black and white gloss finish.

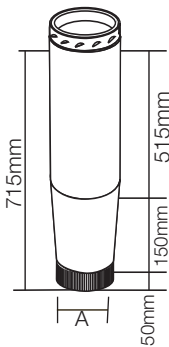

Size	Dimension (A)	Code number
130mm	125mm	4570405N
150mm	150mm	4570406N
180mm	175mm	4570407N
200mm	200mm	4570408N

For painted option add "B" for black and "W" for white, e.g. for 150ID black version the part number is 4570406NB.

Inspection length – standard (N1/D)

Use to provide access for inspection or cleaning via an insulated lockable door. This component is only suitable for negative pressure/dry non-condensing applications. For positive pressure or wet condensing applications use the metu inspection length below.

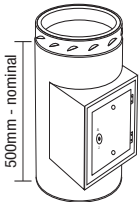

Size	Code number
100mm	N/A
130mm	4576205N
150mm	4576206N
180mm	4576207N
200mm	4576208N
250mm	4576210N
304mm	4576212N
355mm	4576214N

Inspection length – metu (P1/W)

Use to provide access for inspection and cleaning. To be used for positive pressure and wet systems where the flue gases are likely to condensate within the chimney system. Suitable for flue gas temperatures up to 200°C at 200Pa.

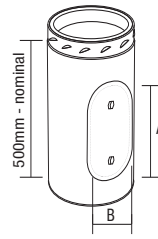

Size	Dimension (mm)		Code number
	A	B	
100mm	180	70	4576304N
130mm	180	80	4576305N
150mm	200	100	4576306N
180mm	200	100	4576307N
200mm	200	100	4576308N
250mm	200	100	4576310N
304mm	200	100	4576312N
355mm	200	100	4576314N

Adjustable lengths

The adjustable length offers a degree of flexibility when standard length dimensions are not suitable. As the insulation density will vary with application, these components should always be located at least 300mm from any combustible material. All adjustable lengths are supplied with separate insulating material for insertion into the annulus once the installed length has been determined.

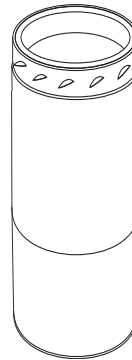

Short Version (300m - 400mm)	
Size	Code number
100mm	4576604N
130mm	4576605N
150mm	4576606N
180mm	4576607N
200mm	4576608N
250mm	4576610N
304mm	4576612N
355mm	4576614N

Long Version (375mm - 550mm)	
Size	Code number
100mm	4574604N
130mm	4574605N
150mm	4574606N
180mm	4574607N
200mm	4574608N
250mm	4574610N
304mm	4574612N
355mm	4574614N

Where Adjustable Lengths are required for positive pressure and condensate resistance, two seals are required per component as detailed below. See page 18.

Seal requirement for Adjustable Lengths

Sizes 100mm to 250mm

2pcs Seal Part No (40063XX)

Sizes 305mm to 355mm

1pc Seal part No (40064XX)

1pc Adjustable Seal part No (40065XX)

Lengths

Duct drain length

Used in an inclined position to trap condensate and permit drainage. It is fitted with a standard stainless steel BSP thread connection and incorporates an internal back flow dam.

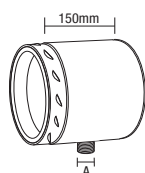

Size	Dimension (A)	Code number
100mm	1" BSP	4576804N
130mm	1" BSP	4576805N
150mm	1" BSP	4576806N
180mm	1" BSP	4576807N
200mm	1" BSP	4576808N
250mm	1" BSP	4576810N
304mm	1" BSP	4576812N
355mm	1" BSP	4576814N

Probe length

Supplied with a M16 threaded washer and bolt to facilitate a commissioning sampling probe. Cover jacket supplied to cover sampling point when not in use.

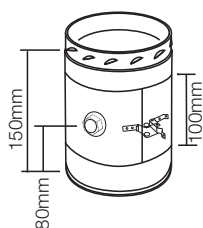

Size	Code number
100mm	N/A
130mm	4576705N
150mm	4576706N
180mm	4576707N
200mm	4576708N
250mm	4576710N
304mm	4576712N
355mm	4576714N

Locking band

The locking band must be used on all joints and **are included** with each component excluding terminals.

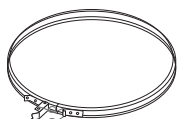

100mm to 250mm

Size	Code number
100mm	4578604
130mm	4578605
150mm	4578606
180mm	4578607
200mm	4578608
250mm	4578610
304mm	4578612
355mm	4578614



304mm to 355mm

The Locking Band for the 304mm and 355mm sizes is of a structural design and incorporates both a toggle latch and tightening bolt.

Joint sealing ring (W/P1)

This optional component is available for all diameters and is located in the joint groove as detailed in the Installation Instructions and on page 3. This component provides a moisture and gas resistant seal to a pressure of 200Pa as tested to P1 under EN 1856-1. The seal would normally be used on applications where there is a likelihood that condensation of the flue gases could result or where the chimney is operating under positive pressure conditions where the flue gas temperature will not exceed 200°C (T200).

Important: SFL seal lubricating compound should be applied around the surface of the seal and interfacing surface prior to making the joint. It is also recommended that the seal is carefully bonded to the fixing groove prior to installation with a suitable silicon adhesive / sealant.

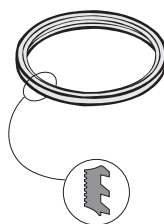

Size	Code number
100mm	4006310
130mm	4006313
150mm	4006315
180mm	4006318
200mm	4006320
250mm	4006325
304mm	4006430
355mm	4006435

Joint sealing ring (W/P1) for 305mm and 355mm Adjustable Lengths ONLY.

These seals are to only be used for the internal slip section of the 305mm and 355mm Adjustable Lengths. All other sizes utilise the standard Joint Sealing Ring as detailed above, Part No. 40063XX in the slip section. See page 18.

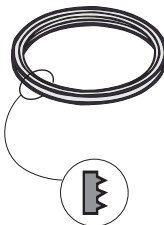

Size	Code number
304mm	4006530
355mm	4006535

Seal lubricant (P1/W)

This must be applied around the circumference of the fitted seal to provide a lubricated interface between the seal and the liner when the product is used for positive pressure and wet applications.



Seal lubricant	4007500
----------------	---------

Fittings

Adaptors

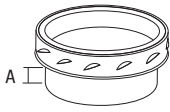

Appliance adaptor

Used to connect the appliance outlet to the Nova SM chimney system. This adaptor is also used for connection of the draught regulator to the branch of a 90° tee.

Size	Dimension A (mm)	Code number
100mm	50	4578504N
130mm	50	4578505N
150mm	50	4578506N
180mm	50	4578507N
200mm	50	4578508N
250mm	50	4578510N
304mm	50	4578512N
355mm	50	4578514N

Appliance adaptor (imperial)

Used for connection to appliances with imperial spigots. These are used for imperial stove connections and are not suitable for pressure and condensate resistance.

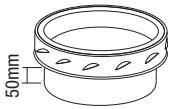

Size	Code number
125mm	4578405N
175mm	4578407N

Adaptor to flex

Used to connect the Nova SM product to a flexible flue liner.

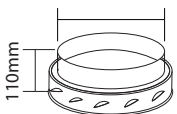

Size	A	Code number
100mm	107	45750104N
130mm	134	45750105N
150mm	161	45750106N
180mm	187	45750107N
200mm	218	45750108N
250mm	263	45750110N
304mm	313	45750112N
355mm	364	45750114N

Appliance increaser adaptor

Used to increase the appliance outlet size by one diameter.

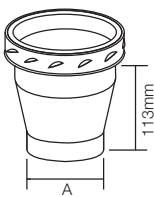

Size	A	Code number
100mm	80	4579404N
150mm	123	4579505N
150mm	130	4579405N

Supra to Nova SM adaptor

Used to either connect the chimney system to the appliance or to the SFL Supra chimney system.

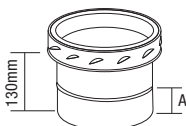

Size	Dimension A (mm)	Code number
100mm	63	4579604N
130mm	63	4579605N
150mm	63	4579606N
180mm	42	4579607N
200mm	42	4579608N
250mm	42	4579610N
304mm	42	4579612N
355mm	42	4579614N

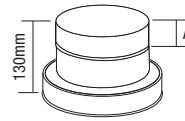

Nova SM to Supra adaptor

Designed to facilitate connection from the Nova SM to Supra chimney system.

Size	Dimension A (mm)	Code number
100mm	63	4579704N
130mm	63	4579705N
150mm	63	4579706N
180mm	42	4579707N
200mm	42	4579708N
250mm	42	4579710N
304mm	42	4579712N
355mm	42	4579714N

SM250/SMW to Nova SM adaptor

Available to convert from SM/SMW to Nova SM with an installed height of 75mm. Code Number 45748XXN, where XX is the diameter, e.g. 4574806N is 150mm(6").

Bespoke adaptors can be manufactured to order, please refer to SFL Technical Services.

Elbows

15° elbow

Provides a 15° change of direction from the vertical. See technical data on page 14 for dimensions.

Size	Code number
100mm	4575404N
130mm	4575405N
150mm	4575406N
180mm	4575407N
200mm	4575408N
250mm	4575410N
304mm	4575412N
355mm	4575414N

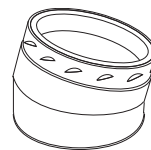

30° elbow

Provides a 30° change of direction from the vertical. See technical data on page 14 for dimensions.

Size	Code number
100mm	4575504N
130mm	4575505N
150mm	4575506N
180mm	4575507N
200mm	4575508N
250mm	4575510N
304mm	4575512N
355mm	4575514N

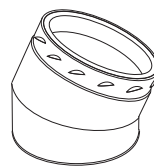

40° elbow

Provides a 40° change of direction from the vertical. See technical data on page 14 for dimensions.

Size	Code number
100mm	4575604N
130mm	4575605N
150mm	4575606N
180mm	4575607N
200mm	4575608N
250mm	4575610N
304mm	4575612N
355mm	4575614N

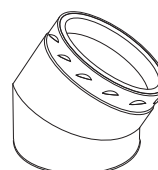

Fittings

45° elbow

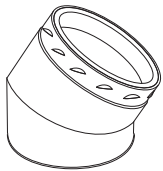

Provides a 45° change of direction from the vertical. See technical data on page 14 for dimensions.

Size	Code number	
100mm	4575704N	
130mm	4575705N	
150mm	4575706N	
180mm	4575707N	
200mm	4575708N	
250mm	4575710N	
300mm	4575712N	
350mm	4575714N	

NOTE: To allow the elbow to achieve a full range of movement, all elbows are supplied with un-barbed couplers on the female end and therefore are not designed to twist-lock together.

90° elbow

Provides a 90° change of direction.

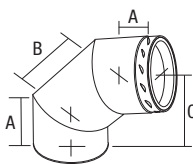

Dimension lines relate to centre line of flue.

Size	Dimension (mm)			Code number
	A	B	C	Nova SM
100mm	91	126	180	4575904N
130mm	98	136	193	4575905N
150mm	102	144	204	4575906N
180mm	108	156	219	4575907N
200mm	112	165	229	4575908N
250mm	123	185	254	4575910N
304mm	132	217	285	4575912N
355mm	140	235	306	4575914N

85° elbow

Provides a 85° change of direction from the vertical. Used in condensing applications where a 5° incline to the horizontal is required for condensate drainage.

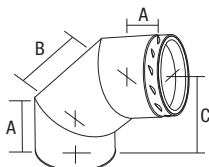

Dimension lines relate to centre line of flue.

Size	Dimension (mm)			Code number
	A	B	C	
100mm	91	126	192	4575804N
130mm	98	136	207	4575805N
150mm	102	144	217	4575806N
180mm	108	156	233	4575807N
200mm	112	165	244	4575808N
250mm	123	185	270	4575810N
304mm	132	217	297	4575812N
355mm	140	235	318	4575814N

87° elbow

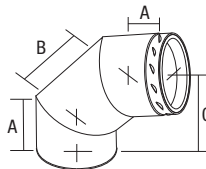

Dimension lines relate to centre line of flue.

Provides a 87° change of direction from the vertical. Used in condensing applications where a 3° incline to the horizontal is required for condensate drainage for low headroom.

Size	Dimension (mm)			Code number
	A	B	C	
100mm	91	126	185	4574904N
130mm	98	136	200	4574905N
150mm	102	144	210	4574906N
180mm	108	156	226	4574907N
200mm	112	165	236	4574908N
250mm	123	185	262	4574910N
304mm	132	217	291	4574912N
355mm	140	235	312	4574914N

Tees

90° tee

Used at the base of a vertical chimney, or for horizontal header configurations.

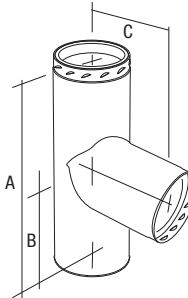

Size	Dimension (mm)			Code number
	A	B	C	
100mm	300	180	140	4573004N
130mm	330	195	155	4573005N
150mm	350	205	165	4573006N
180mm	380	220	180	4573007N
200mm	400	230	190	4573008N
250mm	450	255	215	4573010N
304mm	500	265	240	4573012N
355mm	550	305	265	4573014N

95° tee

Used at the base of a vertical chimney, or for horizontal header configurations. Allows for a 5° incline on wet systems to allow for condensate drainage.

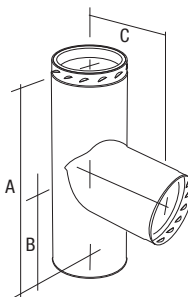

Size	Dimension (mm)			Code number
	A	B	C	
100mm	300	180	140	4576404N
130mm	330	195	155	4576405N
150mm	350	205	165	4576406N
180mm	380	220	180	4576407N
200mm	400	230	190	4576408N
250mm	450	255	215	4576410N
304mm	500	286	240	4576412N
355mm	550	305	270	4576414N

93° tee

Used at the base of a vertical chimney, or for horizontal header configurations. Allows for a 3° incline on wet systems to allow for condensate drainage.

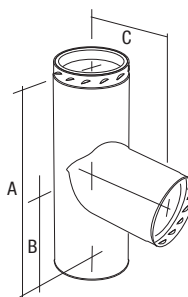

Size	Dimension (mm)			Code number
	A	B	C	
100mm	300	180	140	4576404N
130mm	330	195	155	4576405N
150mm	350	205	165	4576406N
180mm	380	220	180	4576407N
200mm	400	230	190	4576408N
250mm	450	255	215	4576410N
304mm	500	286	240	4576412N
355mm	550	305	270	4576414N

Fittings

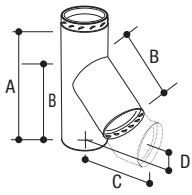

135° tee

Used at the base of a vertical chimney, or to allow a smooth transition from the horizontal to vertical plain when used with a 45° elbow.

Size	Dimension (mm)		Code number
	A	B	
100mm	495	325	4576504N
130mm	495	340	4576505N
150mm	495	375	4576506N
180mm	745	420	4576507N
200mm	745	450	4576508N
250mm	745	520	4576510N
304mm	745	585	4576512N
355mm	995	650	4576514N

Size	Dimension 135° tee (mm)			
	With 40° elbow		With 45° elbow	
	C	D	C	D
100mm	385	23	385	31
130mm	407	22	407	30
150mm	439	29	439	38
180mm	481	37	481	47
200mm	509	43	509	53
250mm	577	55	577	65
304mm	625	73	625	84
355mm	688	84	688	96

90° and 95° reducing tee

Used where a reduction in branch diameter is required, for example on manifold tees etc. All reducing tees have a 533mm installed body length.

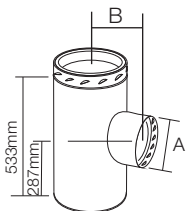
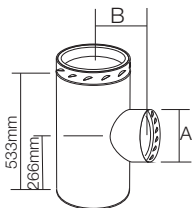

Size (mm)	Branch A (mm)	B (mm)	90° Code	95° Code
130	100	148	4559001	4559501
150	100	158	4559002	4559502
150	130	158	4559003	4559503
180	100	173	4559009	4559509
180	130	173	4559011	4559511
180	150	173	4559013	4559513
200	100	183	4559015	4559515
200	130	183	4559017	4559517
200	150	183	4559019	4559519
200	180	183	4559021	4559521
250	100	208	4559023	4559523
250	130	208	4559025	4559525
250	150	208	4559026	4559526
250	180	208	4559027	4559527
250	200	208	4559028	4559528
304	100	233	4559029	4559529
304	130	233	4559030	4559530
304	150	233	4559031	4559531
304	180	233	4559032	4559532
304	200	233	4559033	4559533
304	250	233	4559034	4559534
355	100	258	4559035	4559535
355	130	258	4559036	4559536
355	150	258	4559037	4559537
355	180	258	4559038	4559538
355	200	258	4559039	4559539
355	250	258	4559040	4559540
355	304	258	4559041	4559541

Tee Components

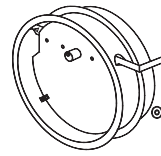

Draught regulator

Dual action draught regulator suitable for gas, oil and solid fuel applications. Designed to be used with SFL chimney systems where excessive draught is likely to create combustion problems. When used with the Nova SM chimney system, the regulator should be applied with the 45785XXN appliance adaptor (in turn located onto the 90° tee branch).

Size	Code number
100mm	3192004
130mm	3192005
150mm	3192006
180mm	3192007
200mm	3192008
250mm	3192010
304mm	3192012
355mm	3192014

Locking plug

Used to close off the branch or base of a tee.

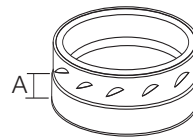

Size	Dimension A (mm)	Code number
100mm	50	4579104N
130mm	50	4579105N
150mm	50	4579106N
180mm	50	4579107N
200mm	50	4579108N
250mm	50	4579110N
304mm	50	4579112N
355mm	50	4579114N

Condensate collector

Used at the bottom of a vertical chimney to facilitate the drainage of condensate from the system.

Fitted with a stainless steel BSP external thread drain connection.

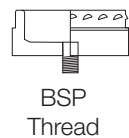
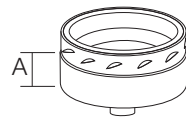

Size	BSP	Dimension A (mm)	Code number
100mm	1"	50	4576904N
130mm	1"	50	4576905N
150mm	1"	50	4576906N
180mm	1"	50	4576907N
200mm	1"	50	4576908N
250mm	1"	50	4576910N
304mm	1"	50	4576912N
355mm	1"	50	4576914N

Misc Fittings

Eccentric Increaser

Designed specifically for condensing applications to provide an increase in diameter while preventing pooling of condensation in horizontal or inclined runs.

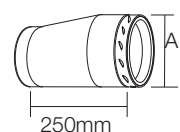

Size	Flue Size A	Code number
150mm	200mm	4570606N
180mm	250mm	4570607N
200mm	250mm	4570608N
200mm	304mm	4570708N
250mm	304mm	4570610N
250mm	355mm	4570710N

Fittings

Support length / Strut / Guy Attachment



A 117mm installed length which incorporates a plate located 33mm from the bottom edge and features slotted holes for rotational adjustment. For use with the universal support plate or the telescopic floor support. This component also doubles as a strut / guy attachment length offering anchoring points to which guys, or preferably rigid stays can be secured using M8 nuts and bolts. Manufactured from stainless steel.

Size	Code number
100mm	4578804N
130mm	4578805N
150mm	4578806N
180mm	4578807N
200mm	4578808N
250mm	4578810N
304mm	4578812N
355mm	4578814N

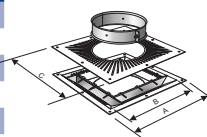

Solid fuel and oil fire appliance >T250 (>250°C)

The following components MUST be used where Nova SM is used on solid fuel or oil fired appliances where the flue gas temperature exceeds 250°C and / or where the chimney system penetrates a combustible floor. Each ventilated component offers a 50mm clearance to combustible materials.

Ventilated ceiling support

Used to both support and firestop the chimney system when it passes through the first combustible floor directly above the appliance. The support component incorporates a patented intumescent matrix design which expands rapidly with temperature and seals the plate to prevent the potential spread of fire from the room below.

Size	Dimension (mm)			Code number
	A	B	C	
100mm	331	251	349	7072710
130mm	361	281	379	7072713
150mm	381	301	399	7072715
180mm	411	331	429	7072718
200mm	431	351	453	7072720
250mm	481	401	501	7072725
300mm	531	451	551	7072730

For painted variations add the following letters after the part number:- White: ZW
Black: ZB

Floor penetration components

Gas and oil fire appliance <T250 (<250°C)

The following components MUST be used on gas or oil fired appliances where the flue gas temperatures does not exceed 250°C and / or where the chimney passes through a non-combustible floor.

Ceiling support

Provides a 50mm air gap clearance to a penetrated floor or ceiling and is only used where Nova SM penetrates a non-combustible floor, and / or services a gas or oil fired appliance where the flue gas temperature does not exceed 250°C.

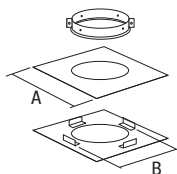

Size	Dimension (mm)		Code number
	A	B	
100mm	300	250	4502704
130mm	330	280	4502705
150mm	355	305	4502706
180mm	381	331	4502707
200mm	406	356	4502708
250mm	457	407	4502710
304mm	507	457	4502712
355mm	558	508	4502714

Firestop spacer

Used to provide location, fire and dust stopping where Nova SM is used through non-combustible floors, and / or serves a gas or oil fired appliance where the flue gas temperatures does not exceed 250°C. Does not load bear.

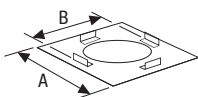

Size	Dimension (mm)		Code number
	A	B	
100mm	300	250	4508704
130mm	330	280	4508705
150mm	355	305	4508706
180mm	381	331	4508707
200mm	406	356	4508708
250mm	457	407	4508710
304mm	507	457	4508712
355mm	558	508	4508714

Ventilated firestop

Used where the chimney passes through the upper combustible floors and where sections below the floor are enclosed within a non combustible shaft. This item does not load bear.

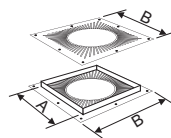

Size	Dimension (mm)		Code number
	A	B	
100mm	251	349	5508310
130mm	281	379	5508313
150mm	301	399	5508315
180mm	331	429	5508318
200mm	351	453	5508320
250mm	402	501	5508325
300mm	452	551	5508330

Supports

Wall support bracket

Used to take the vertical load of the chimney when supported from a wall. The support bracket is fully adjustable allowing varying clearances from the wall (50mm as standard). Requires M10 wall fixings.

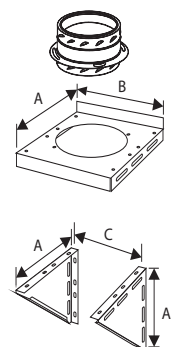

Size	Dimension (mm)		
	A	B	C
100mm	252	281	235
130mm	282	311	265
150mm	302	331	285
180mm	331	360	314
200mm	355	384	338
250mm	403	432	384
304mm	453	482	434
355mm	504	533	485

'C' – Wall fixing centres

Support bracketry

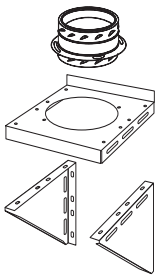

Size	Code number	
	Stainless	Galvanised
100mm	4572304	4572204
130mm	4572305	4572205
150mm	4572306	4572206
180mm	4572307	4572207
200mm	4572308	4572208
250mm	4572310	4572210
304mm	4572312	4572212
355mm	4572314	4572214

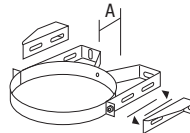

Wall band extension pieces

Used with wall bands, these components allow the clearance between the wall and outer surface of the chimney to be increased. Where externally applied, the intervals between wall band fixing centres must be reduced from 4.0 metres to 3.5 metres. The maximum clearance is as detailed below.

Size	Code number					
	31**136		31**180		31**245	
	Min	Max	Min	Max	Min	Max A
100mm	65mm	105mm	-	-	-	-
130mm	50mm	100mm	-	-	-	-
150mm	50mm	100mm	-	-	-	-
180mm	50mm	100mm	-	-	-	-
200mm	50mm	100mm	-	-	-	-
250mm	-	-	50mm	100mm	-	-
304mm	-	-	-	-	75mm	140mm
355mm	-	-	-	-	50mm	120mm

Code numbers ** use 19 for stainless steel, and 20 for galvanised.

Telescopic floor support

Used at floor level to take the vertical weight of the chimney. For all diameters the height is adjustable between 296mm and 536mm at 30mm increments. Supplied complete with a Support Length.

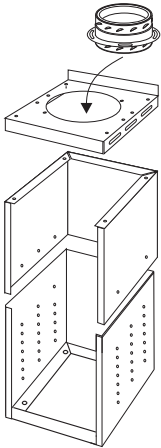

Size	Code number	
	Stainless	Galvanised
100mm	3101104	3102104
130mm	3101105	3102105
150mm	3101106	3102106
180mm	3101107	3102107
200mm	3101108	3102108
250mm	3101110	3102110
304mm	3101112	3102112
355mm	3101114	3102114

Roof support

Provided with adjustable gimbal plates to permit a chimney to be supported on roof joists, trussed rafters etc. Maximum suspended chimney length supported is 6.0 metres and maximum total length supported is 9.0 metres.

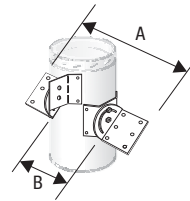

Size	Dimension (mm)		Code number
	A*	B	
100mm	466	253	0102900
130mm	490	280	0102900
150mm	515	304	0102900
180mm	545	330	0102900
200mm	570	356	0102900
250mm	618	406	0102900
304mm	668	456	0102900
355mm	719	506	0102900

*Minimum distance between roof trusses.

Adjustable Split Band

Offers lateral support to the chimney system. The split band has adjustable brackets to allow the support of inclined runs. Design for use with M10 Drop Rod.

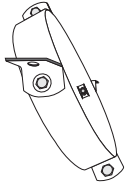

Size	Code number
100mm	3123150
130mm	3123180
150mm	3123200
180mm	3123200
200mm	3123250
250mm	3123300
304mm	3123350
355mm	3123400

Wall bands

Wall bands provide lateral support for the chimney and must be used at intervals not exceeding 4.0 metres beyond any load bearing support. For external applications it is recommended that the stainless steel version is used.

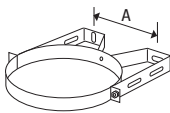

Size	Dimension A (mm)	Code number	
		Stainless	Galvanised
100mm	112	3115154	3116154
130mm	142	3115185	3116185
150mm	162	3115205	3116205
180mm	192	3115234	3116234
200mm	212	3115255	3116255
250mm	266	3115305	3116305
304mm	316	3115355	3116355
355mm	366	3115405	3116405

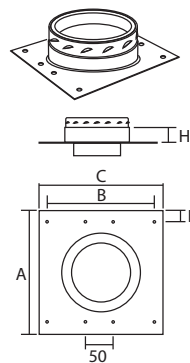

Single wall to Nova SM anchor plate

Designed to be used when connecting Nova SM to a lintel or pre-cast chamber. A short section of liner projects a nominal 32mm through the bottom of the plate. Installed length "H" is 40mm while "E" is 27mm and there are 8 x 11mm fixing holes at the centres shown in the table below. Manufactured in stainless steel.

Size	Dimension (mm)			Code number
	A	B	C	
100mm	281	196	252	4577504N
130mm	311	226	282	4577505N
150mm	331	246	302	4577506N
180mm	360	275	331	4577507N
200mm	384	299	355	4577508N
250mm	432	345	403	4577510N
304mm	482	395	453	4577512N
355mm	533	446	504	4577514N

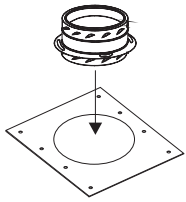

Universal support plate

A support plate designed for use with bespoke bracketry such as Uni-Strut/Neissing or site fabricated. Supplied complete with a Support Length. Fixing hole size 11mm to suit M10 fixings.

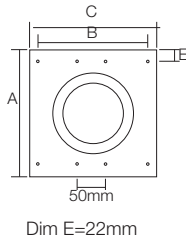

Size	Dimension (mm)			Code number	
	A	B	C	Stainless	Galvanised
100mm	281	196	252	311904154	311004154
130mm	311	226	282	311905184	311005184
150mm	331	246	302	311906204	311006204
180mm	360	275	331	311907234	311007234
200mm	384	299	355	311908254	311008254
250mm	432	345	403	311910304	311010304
304mm	482	395	453	311912354	311012354
355mm	533	446	504	311914404	311014404

Dim E=22mm

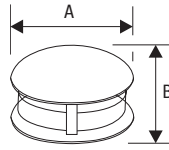

Round top

The round top offers a greater degree of protection against driving rain and wind, recommended for exposed locations.

Size	Dimension (mm)		Code number
	A	B	
100mm	255	155	4573104
130mm	300	159	4573105
150mm	300	157	4573106
180mm	358	189	4573107
200mm	402	194	4573108
250mm	500	253	4573110
304mm	614	288	4573112
355mm	716	356	4573114

Terminals

The terminals illustrated are suitable for all fuels, with the exception of gas appliances where the chimney is 150mm or less. For such appliances the gas terminal code 45524XX must be used.

Top stub

The terminal offers the least resistance to flue gases and is ideal for solid fuel and oil fired appliances, providing there is drainage at the base of the chimney.



Size	Dimension A (mm)	Code number
100mm	100	4570804
130mm	100	4570805
150mm	100	4570806
180mm	100	4570807
200mm	100	4570808
250mm	100	4570810
304mm	100	4570812
355mm	100	4570814

Top stub c/w mesh

The terminal offers the least resistance to flue gases and is ideally suited for condensing/high efficiency appliances. Not suitable for solid fuel application or where there is no provision for drainage below termination.

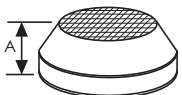

Size	Dimension A (mm)	Code number
100mm	100	4570704
130mm	100	4570705
150mm	100	4570706
180mm	100	4570707
200mm	100	4570708
250mm	100	4570710
304mm	150	4570712
355mm	150	4570714

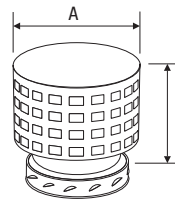

Gas terminal

The gas terminal is available from 100mm to 355mm internal diameter.

Size	Dimension (mm)		Code number
	A	B	
100mm	236	118	4552404
130mm	236	118	4552405
150mm	267	118	4552406
180mm	293	220	4552407
200mm	320	220	4552408
250mm	368	220	4552410
304mm	421	220	4552412
355mm	469	220	4552414

Rain cap

The rain cap offers a degree of protection from rain and is suitable for solid fuel and oil fired appliances.

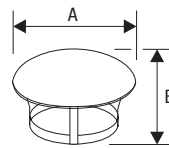

Size	Dimension (mm)		Code number
	A	B	
100mm	255	192	4577304
130mm	255	197	4577305
150mm	300	204	4577306
180mm	358	265	4577307
200mm	402	265	4577308
250mm	500	300	4577310
304mm	614	345	4577312
355mm	716	385	4577314

Storm cowl

The storm cowl is designed to offer the maximum protection against driving rain and strong winds. Please note that this is not an anti-down draught terminal.

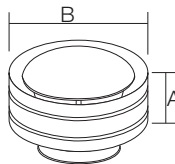

Size	Dimension (mm)		Code number
	A	B	
100mm	165	270	4578704
130mm	165	294	4578705
150mm	165	319	4578706
180mm	165	344	4578707
200mm	165	369	4578708
250mm	210	419	4578710

Terminals, flashings and trims

Storm cowl with mesh

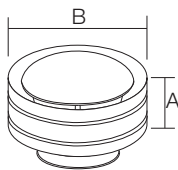

The storm cowl is designed to offer the maximum protection against driving rain and strong winds. Please note that this is not an anti-down draught terminal.

Size	Dimension (mm)		Code number
	A	B	
100mm	165	270	4578904
130mm	165	294	4578905
150mm	165	319	4578906
180mm	165	344	4578907
200mm	165	369	4578908
250mm	210	419	4578910

Aluminium flashings

The SFL aluminium flashing range offers a competitive alternative to the traditional lead flashing, while still maintaining a traditional design and malleable material.

All aluminum flashings require a storm collar.

Flat flashing

For flat or nearly flat roofs.

Size	Dimension (mm)			Code number
	A	B	C	
100mm	160	250	495	70000006
130mm	190	280	495	70000007
150mm	210	300	495	70000009
180mm	235	325	660	70000010
200mm	260	350	660	70000011
250mm	310	400	660	70000012
304mm	360	450	660	70000013
355mm	410	500	820	70000014

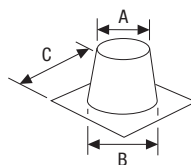

Flashings

EPDM synthetic rubber flashings

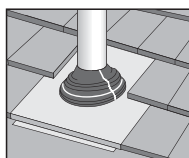

These flashings offer an installation friendly alternative to the traditional type of roof flashing. The EPDM flashings are available in four sizes which covers an external diameter range between 60mm and 450mm.

The selection of the correct flashing depends on the outside chimney diameter and intended roof pitch. The table identifies which flashing should be used. Each consists of a malleable aluminium base to which an EPDM rubber cone is sealed. The cone is easily trimmed on site to suit the external diameter of the chimney. Separate Installation Instructions are provided with every flashing.

The EPDM flashing system will effectively seal and remain pliant over a wide range of external chimney surface temperature extremes from -30° to 115°C. The EPDM cones have also been proven to withstand intermittent surface temperatures of up to 150°C.

EPDM flashings should not be used on single wall chimney systems serving solid fuel appliances or any application where the potential surface temperature of the chimney will exceed the maximum design temperatures details above.

Please consult SFL technical department for further information.

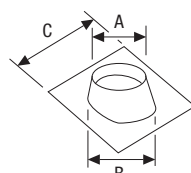

5° – 30° adjustable flashing

For low pitched roofs.

Size	Dimension (mm)			Code number
	A	B	C	
100mm	160	250	495	70053006
130mm	190	280	495	70053007
150mm	210	300	660	70053009
180mm	235	325	660	70053010
200mm	260	350	660	70053011
250mm	310	400	660	70053012
304mm	360	450	820	70053013
355mm	410	500	965	70053014

32° – 45° adjustable flashing

For high pitched roofs.

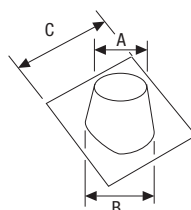

Size	Dimension (mm)			Code number
	A	B	C	
100mm	160	332	660	70324506
130mm	190	375	660	70324507
150mm	210	403	660	70324509
180mm	240	440	820	70324510
200mm	260	475	820	70324511
250mm	310	546	820	70324512
304mm	360	617	820	70324513
355mm	410	689	1219	70324514

C for base is square (C X C)

Storm collar

Used to weather the top of the flashing, supplied with a tube of silicon sealant.

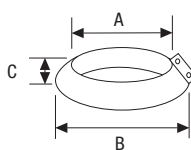

Size	Dimension (mm)			Code number
	A	B	C	
100mm	152	255	70	70123406
130mm	177	280	70	70123407
150mm	202	301	70	70123409
180mm	227	330	70	70123410
200mm	252	351	70	70123411
250mm	302	401	70	70123412
304mm	352	451	70	70123413
355mm	402	501	70	70123414

Size	Ext. Dia. A (mm)	Roof Pitch	Flashing No.	Cone Index Cut Line
100mm	150	0 – 45°	2	C
130mm	180	0 – 40°	2	E
150mm	200	0 – 30°	2	F
150mm	200	0 – 45°	3	C
180mm	230	0 – 40°	3	D
200mm	250	0 – 35°	3	F
250mm	300	0 – 30°	3	I
250mm	300	0 – 45°	4	A
304mm	350	0 – 40°	4	C
355mm	400	0 – 35°	4	F



Flashing Size	Code No.	Base size (A)
Flashing No. 2	4901020	600x600mm
Flashing No. 3	4901030	764x764mm
Flashing No. 4	4901045	956x956mm

Terminals, flashings and trims

Trim collar

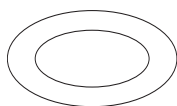

The trim collar is a polished stainless steel circular collar with a nominal 105mm wide circular flange. This item is used to offer an aesthetic closing ring where a chimney passes through an outside wall.

Size	Code number
100mm	4583204
130mm	4583205
150mm	4583206
180mm	4583207
200mm	4583208
250mm	4583210
304mm	4583212
355mm	4583214

Angled Wall Cover Ring

The wall cover ring is designed to offer an aesthetic trim around the chimney where it penetrates a wall at an angle. This component is available in two angle variations, 30° - 40° and 40° - 50°.

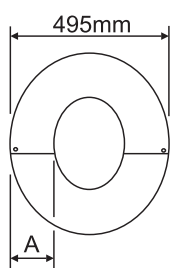

Flue Size	A mm	Code	
		30° - 40°	40° - 50°
130mm	156	5570313N	5570213N
150mm	146	5570315N	5570215N
180mm	131	5570318N	5570218N
200mm	121	5570320N	5570220N

Wall Sleeve

Must be used where a 135° tee is used to pass the chimney through an external wall and thus providing a continuous interrupted run through the wall. Although designed to suit a 280mm maximum width wall, special sizes can be manufactured to order.

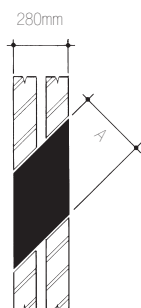

Size	A	Code number
100mm	175	0107104
130mm	200	0107105
150mm	225	0107106
180mm	255	0107107
200mm	280	0107108
250mm	328	0107110
304mm	379	0107112
355mm	429	0107114

Installation and technical data

The illustration below shows a typical support arrangement for an external chimney. The vertical weight of the chimney is taken by a wall support bracket. A removable condensate collector (45769**) is fitted to the underside of the wall support bracket which can also be removed for sweeping. Wall bands (3115**) are then installed every 4.0 metres to provide lateral support. It is essential that adequate bracing is provided directly before and after an offset or change in direction. It is important that adequate fixings are used throughout the chimney system to anchor support components to the structure, such as M10 Rawl bolts etc.

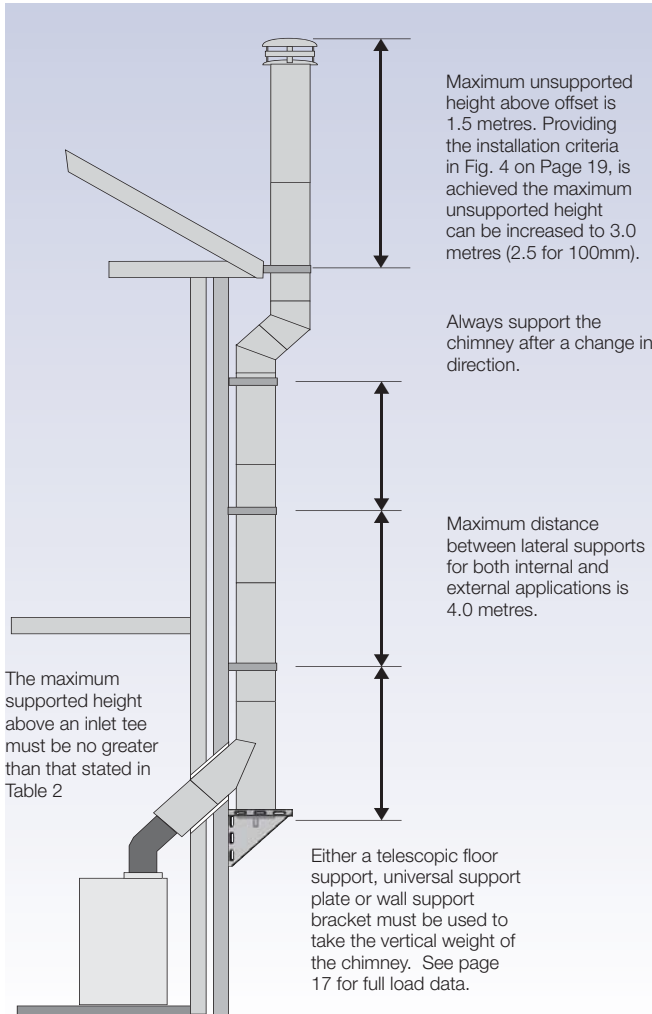

Wall band assembly

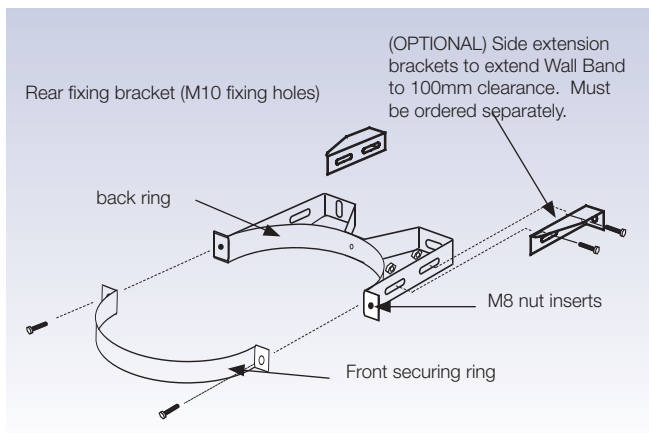

Combustible floor penetration (>250°C)

Where the chimney system is used with appliances producing flue gas temperatures exceeding 250°C, and where the chimney passes through a combustible floor, the following ventilated components **MUST** be used. All floor penetration components are designed to be secured to a pre-built frame construction and lined with a 30 minute fire resistant board to the dimension detailed in table 3.

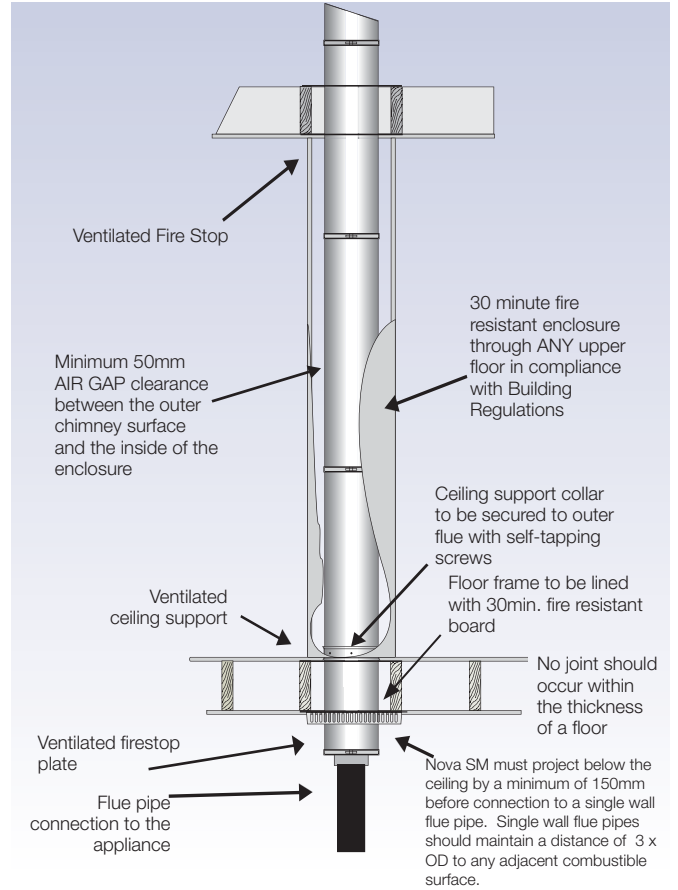

Basic installation diagram of ventilated ceiling support and ventilated firestop components

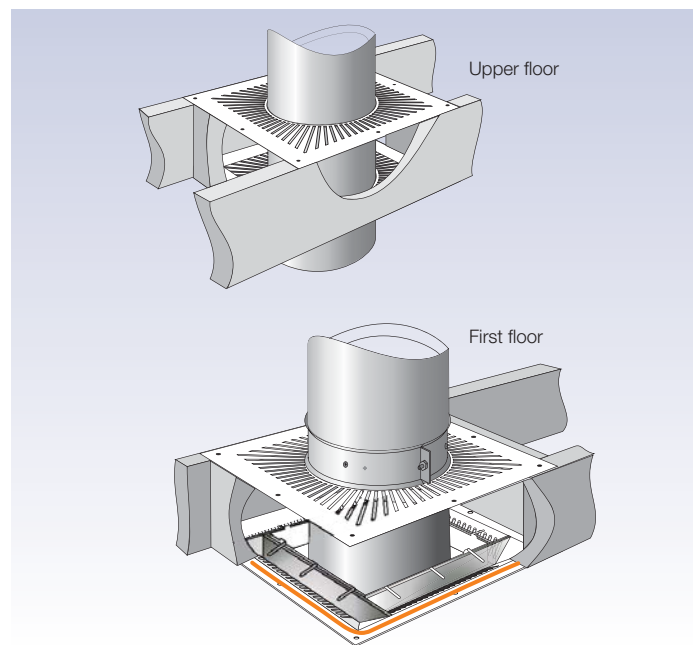

For further information please refer to Installation Instructions.

Installation and technical data

Maximum structural considerations for components

The table below shows the maximum number of metres that can be applied to various components. It is essential that these are not exceeded. Where possible components such as inlet tees should not be vertically loaded but suspended below a support component, so that the vertical weight of the chimney above the tee is taken on the support component and not the tee. Where this is unavoidable, refer to the maximum heights in the table below.

Table 2

Components	Diameter (mm)							
	100	130	150	180	200	250	304	355
Telescopic floor support	30m	26m	23m	20m	18m	15m	12m	11m
Inspection length	13m	13m	13m	13m	13m	13m	13m	12m
Ceiling support	6m	6m	6m	6m	6m	6m	6m	6m
Ventilated ceiling support	6m	6m	6m	6m	6m	6m	6m	6m
Anchor plate	13m	13m	13m	13m	13m	13m	13m	13m
Universal support plate	13m	13m	13m	13m	13m	13m	13m	13m
95° & 90° tee	13m	13m	13m	13m	13m	13m	13m	13m
135° tee	13m	13m	13m	13m	13m	13m	13m	13m

Elbow offset dimensions

This data relates to just two elbows used to form an offset as shown in Fig. 2. It also indicates the installed length of the elbow segments. Data is also provided where standard lengths are also incorporated within the offset, see Fig. 3.

15°

Ø (mm)	A (mm)	B (mm)	C (mm)
100	91	358	47
130	98	385	51
150	102	401	53
180	108	425	56
200	112	440	58
250	123	484	64
304	124	488	64
355	134	527	69

30°

Ø (mm)	A (mm)	B (mm)	C (mm)
100	91	340	91
130	98	366	98
150	102	381	102
180	108	403	108
200	112	418	112
250	123	459	123
304	124	463	124
355	134	500	134

40°

Ø (mm)	A (mm)	B (mm)	C (mm)
100	91	321	117
130	98	346	126
150	102	360	131
180	108	381	139
200	112	396	144
250	123	434	158
304	124	438	159
355	134	473	184

45°

Ø (mm)	A (mm)	B (mm)	C (mm)
100	91	311	129
130	98	335	139
150	102	348	144
180	108	369	153
200	112	382	158
250	123	420	174
304	124	423	175
355	134	457	190

Fig. 2

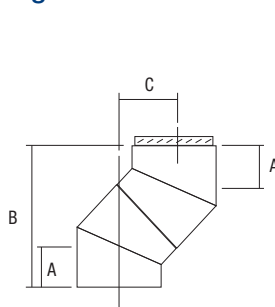
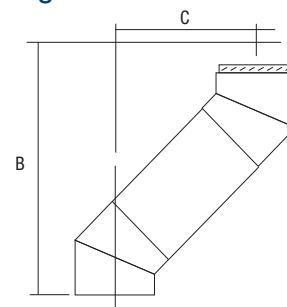

Fig. 3



Elbows are not loadbearing. Vertical runs after changes of direction should be re-supported appropriately.

Ø (mm)	120mm length							
	15°		30°		40°		45°	
	B (mm)	C (mm)	B (mm)	C (mm)	B (mm)	C (mm)	B (mm)	C (mm)
100	474	78	444	151	413	194	396	214
130	501	82	470	158	438	203	420	224
150	517	84	485	162	452	208	433	229
180	541	87	507	168	473	216	454	238
200	556	89	522	172	488	221	467	243
250	600	95	563	183	526	235	505	259
304	603	95	566	184	530	237	508	260
355	643	100	604	194	565	249	542	274

Ø (mm)	250mm length							
	15°		30°		40°		45°	
	B (mm)	C (mm)	B (mm)	C (mm)	B (mm)	C (mm)	B (mm)	C (mm)
100	599	112	556	216	513	278	487	305
130	627	115	582	223	538	287	511	315
150	643	118	597	227	551	292	525	321
180	666	121	620	233	573	299	546	330
200	682	123	634	237	587	305	559	335
250	725	129	676	248	626	319	597	351
304	729	129	679	249	629	320	600	352
355	768	134	717	259	665	333	634	366

Ø (mm)	500mm length							
	15°		30°		40°		45°	
	B (mm)	C (mm)	B (mm)	C (mm)	B (mm)	C (mm)	B (mm)	C (mm)
100	841	177	773	341	704	438	664	482
130	868	180	799	348	729	447	688	492
150	884	182	814	352	743	453	702	498
180	908	185	836	358	764	460	722	506
200	923	187	851	362	779	465	736	512
250	967	193	892	373	817	480	774	528
304	970	194	896	374	821	481	777	529
355	1010	199	933	384	856	494	811	543

Ø (mm)	1000mm length							
	15°		30°		40°		45°	
	B (mm)	C (mm)	B (mm)	C (mm)	B (mm)	C (mm)	B (mm)	C (mm)
100	1324	306	1206	591	1087	760	1018	836
130	1351	310	1232	598	1112	769	1042	846
150	1362	312	1247	602	1128	774	1055	851
180	1391	315	1269	608	1148	782	1076	860
200	1406	317	1284	612	1162	787	1089	865
250	1450	322	1325	623	1200	801	1127	881
304	1453	323	1329	624	1204	802	1130	882
355	1493	328	1366	634	1239	815	1165	897

Installation and technical data

Product weights

Maximum weight of Nova SM per metre run installed, excluding support components.

Ø (mm)	100	130	150	180	200	250	304	355
kg/m	6.6	8.1	9.2	10.8	11.8	14.5	17.1	19.7

**Table 3 – Framing data and dimensions
Ventilated Ceiling Support/Firestop**

Chimney Size	100	130	150	180	200	250	300
'A' Square*	251	281	301	331	351	401	451

Wall support bracket – technical information

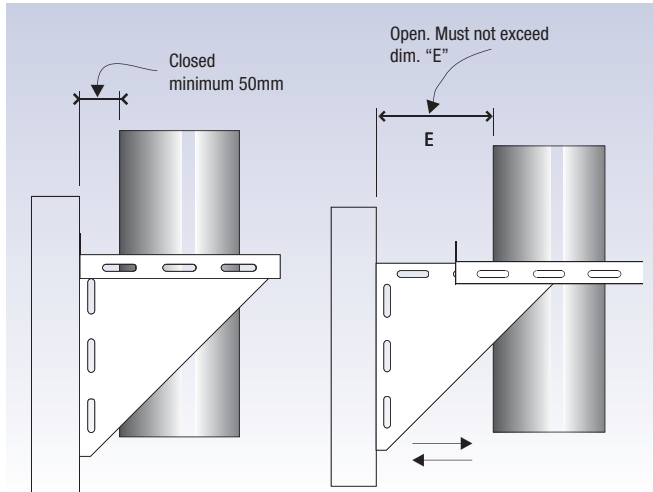

Ventilated ceiling support and ventilated telescopic firestop

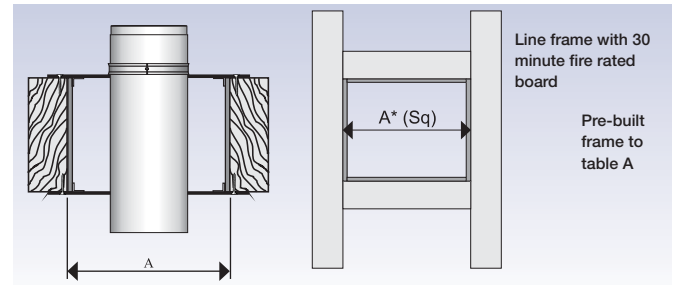

Note: The fire rated board is required under the test conditions of BS 476: Part 20 where the chimney passes through a representative combustible floor.

Size (mm)	E (mm)
100	150
130	150
150	150
180	200
200	200
250	220
304	267
355	293

Support configuration and distance between brackets

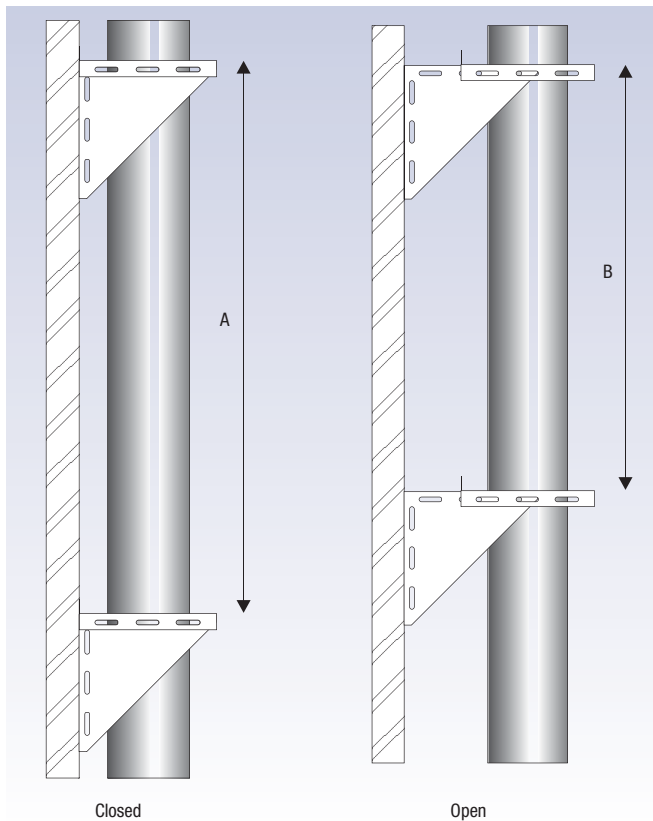

Size (mm)	A (m)	B (m)
100	30	25
130	30	25
150	30	25
180	20	15
200	20	15
250	20	15
304	20	15
355	18	12

This table details the maximum distance in metres between wall supports, based on the support configuration detailed opposite.

Installation and technical data

Detailed installation instructions are provided with all adaptors and terminals, and are also available separately on request, detailed below are key installation requirements for the Nova SM chimney system together with regulatory requirements for the UK. For countries outside of the UK, please refer to your countries own regulations and national standards.

General

The installation of the Nova SM product must be in accordance with local building regulations and associated National Standards and Codes of Practice.

For additional guidance, reference can be made to BS EN 15287-1: 2007: Chimneys – Execution standard for metal chimneys. The National Annex NA of EN 15287-1: 2007 will detail the national requirements for the particular country.

Every chimney section and fitting shall be used as manufactured for assembly on site without any alteration or cutting. Components are joined with a multi barbed twist lock coupler and secured with a locking band. The only exception are elbows, which are designed to allow full rotation of the component and therefore do not have locking barbs on the female end. All components must be installed with the male coupler facing up as detailed in Fig.1 on page 3.

Nova SM is suitable for both internal and external applications. Where used on high efficiency condensing appliances, a range of components are available to permit deliberate drainage of condensate, either back to the condensate removal component within the chimney system, or through the heating appliance. No part of the chimney system should be constructed to form an angle greater than 45° from the vertical.

Although components are included that will permit horizontal application, they should only be used for connection to the appliance. Where the system is being used for a condensing application, sections must run at an angle not less than 3° - 5° from the horizontal, using tees, elbows and fittings designed for that purpose. Failure to provide adequate drainage could lead to premature failure of the product and seal.

Offsets can be constructed using elbows, lengths and adjustable components available within the system. For full details regarding offset dimensions and heights for various elbow/length combinations see tables on page 16. Building Regulations will not permit more than one offset in any chimney run, (i.e. 2 elbows). However that excludes any elbow used to make the connection to the appliance.

Where an offset is used, the length of chimney between the two elbows MUST NOT exceed 20% of the total vertical length of the chimney.

Where serving solid fuel or oil appliances, any part of the chimney which passes through any room other than that in which the appliance using the chimney is situated, should be protected to prevent damage and accidental location of combustible material against the outer skin. It is a building regulation requirement that ANY factory made insulated chimney should be enclosed where passing through a cupboard, storage space or accessible roof space.

Where used with solid fuel or oil appliances producing flue gas temperatures exceeding 250°C, the clearance at floor / ceiling joists must be established using the Ventilated Ceiling Support and Ventilated Firestop. When connecting to a single wall connecting flue or vitreous pipe, at least 150mm of Nova SM must project below the appliance room ceiling before connection is made. This figure however is subject to the manufacturers installation requirements for the single wall connecting flue pipe.

Under no circumstances must there be a joint within the thickness of any floor space. Where passing through a cavity wall a Wall Sleeve must be used and finished with a suitable trim plate.

The internal diameter of the chimney must conform to the requirements of the appliance manufacturers instructions and should not, under any circumstances, be less than the diameter of the appliance outlet.

The height of the chimney will depend on the building structure, however a height of 4.5 metres from the top of the appliance outlet to termination is considered the minimum for solid fuel. To prevent excessive cooling of the flue gases when connecting a single wall flue pipe from the stove to the Nova SM chimney, SFL recommends that the length of the single wall pipe is no more than 1.8 metre within the 4.5 metre height recommendation under Building Regulations.

Adjustable lengths

Each adjustable length is supplied in two halves together with an insulation pack. When required for positive pressure or wet systems, two seals are required in addition to the adjustable length. Fit and lubricate seals as show in the diagram below. Depending on the required finished length of the component, additional insulation is added to the annulus of the top section. The top section is then slid over the bottom section and the component installed. Self-tapping screws are then used to secure the overlapping sections.

The adjustable length does NOT load bear. Always use a wall support or support plate immediately above this component when vertically applied. Adjustable lengths should maintain a clearance of at least 300mm to combustible materials.

Please note that the design of the 300ID and 350ID adjustable length is different to the 100ID to 250ID as detailed in the diagrams below.

100ID - 250ID Adjustable length seal position (Suitable for gas and kerosene oil)

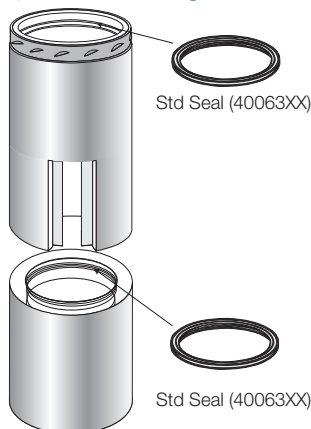

Where condensate and pressure resistance is required, the 100ID to 250ID adjustable length requires two standard seals fitted in both the top and bottom sections of the component as detailed opposite. Ensure that the seal is well lubricated and the interfacing materials are clean and free of dirt prior to assembly.

304ID - 355ID Adjustable length seal position (Suitable for gas only)

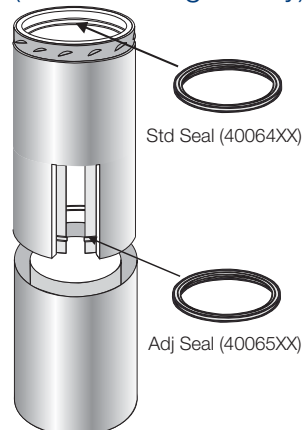

Where condensate and pressure resistance is required two different seals need to be fitted to the upper section. Unlike the 100ID - 250ID, no seal is required in the bottom section. The top seal is located in the groove inside the throat of the male coupler. The bottom seal is stretched over the circumference of the liner and located in the groove. Ensure that the seal is well lubricated and the interfacing materials are clean and free of dirt prior to assembly.

Installation and technical data

Installation criteria for maximum freestanding height

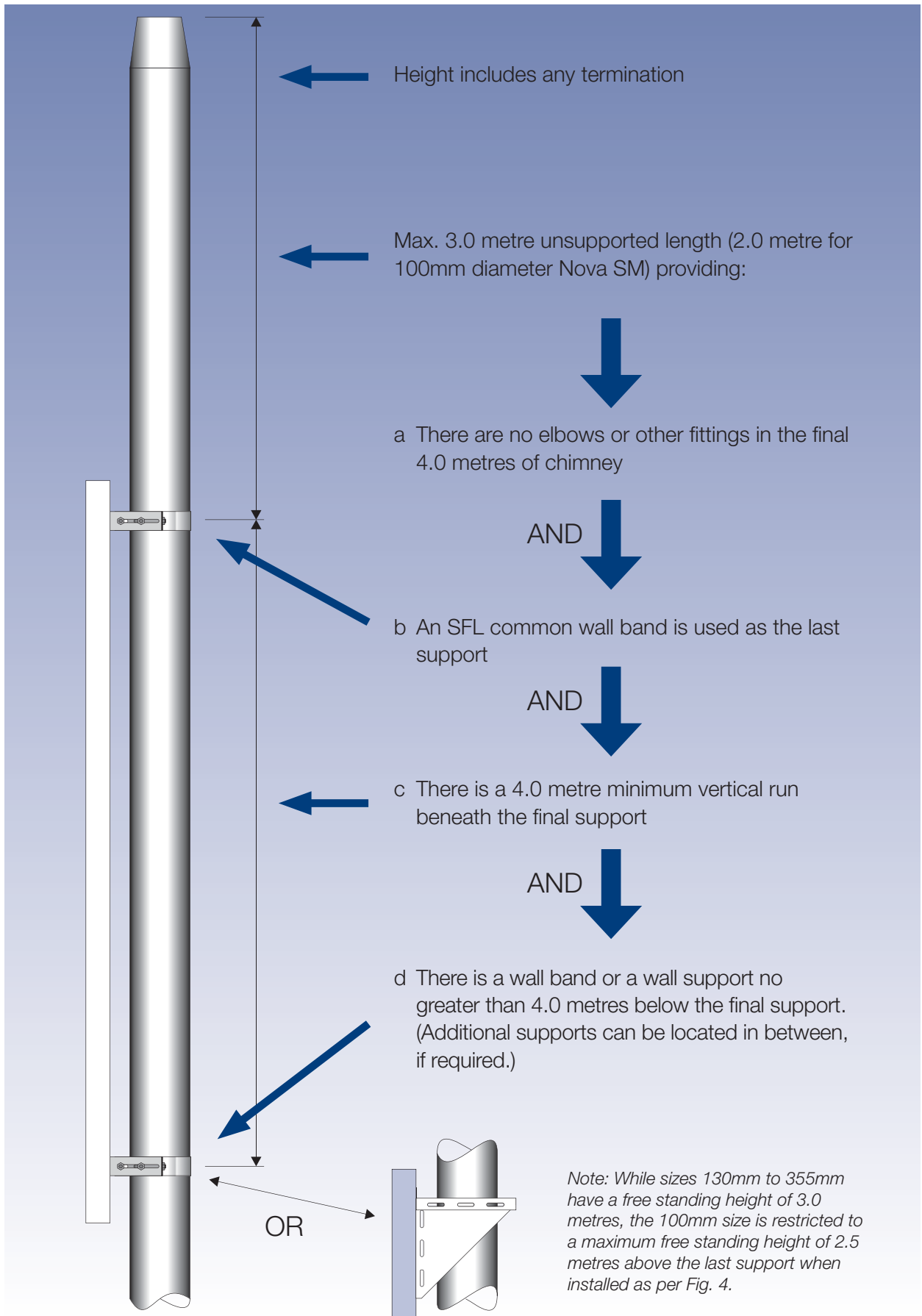

Fig. 4 Maximum unsupported termination detail

Installation – chimney termination

Chimney termination heights and positions are subject to current Building Regulations and National Standards. The illustrations are based Approved Document J of the Building Regulations for solid fuel and oil fired appliances. Domestic natural gas fired appliances are governed by BS5440-1: 2008. All other European countries are governed by their own Regulations, however reference can be made to the countries National Annex of BS EN 15287-1: 2007 for individual requirements.

If the chimney serves an oil fired appliance with a pressure jet burner, the chimney must discharge a minimum 600mm above the roof penetration point, or any adjacent structure, if it is within 750mm. It must also be at least 600mm from any opening into the building and 300mm from any combustible material.

Where used with an oil fired appliance with a vapourising burner, termination must comply with the details in Fig. 5.

Fig. 5 Termination over solid fuel, wood and draught hooded oil fired appliances

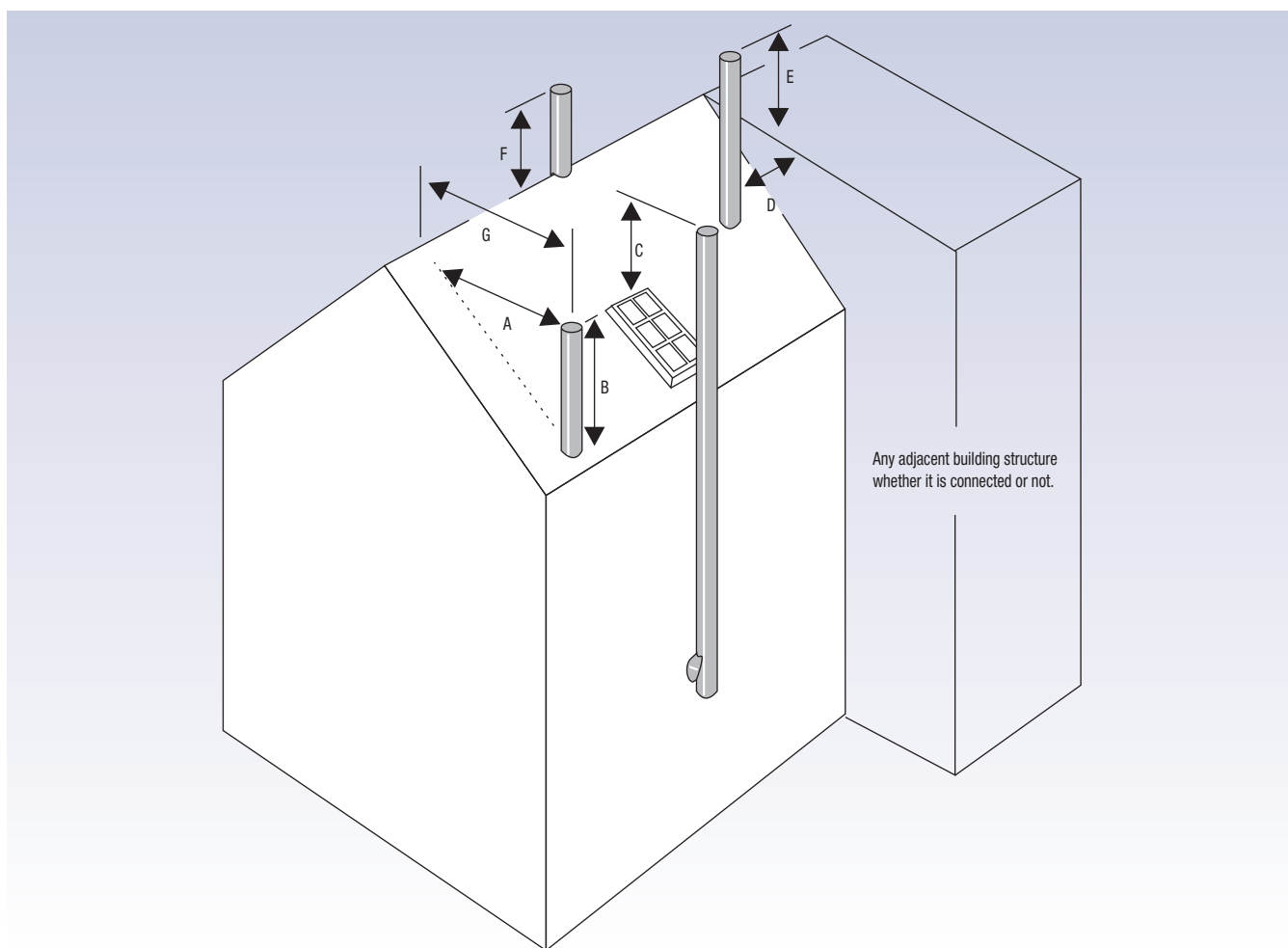

Minimum distance measured from the top of the chimney construction, excluding any pot or terminal.

- A** 2.3 metres horizontally clear of the roof surface, e.g. if the roof pitch is 45°, then the chimney should project 2.3 metres above it.
- B** 1.0 metre, provided A is satisfied, or 600mm above the ridge if G is less than 600mm.
- C** 1.0 metre above the top of any flat roof, and the top of any openable roof light, dormer window or ventilator, etc., if it is located within 2.3 metres.
- D/E** If D is less than 2.3 metres, E shall be not less than 600mm.
- F** 600mm above the ridge.
- G** If G is within 600mm of the ridge then B can be 600mm above the ridge.

NB: All dimensions relate to the underside of the terminal.

Installation – chimney termination over gas appliances

No part of the flue outlet shall be less than 1.5 metres measured horizontally to the roof surface, or any wall. Where the flue terminates above the ridge, it shall do so by not less than 600mm, other than where the flue terminates with a purpose designed ridge terminal.

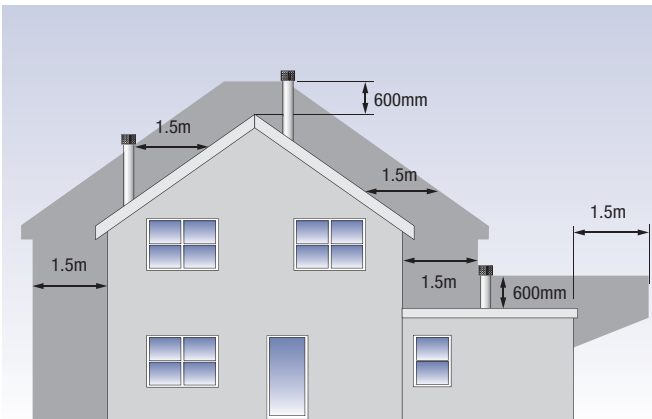

The flue shall terminate outside the dark shaded zone.

Termination through an extension roof adjacent to a sloped roof taller building

Where passing through a roof of an extension or lower part of a building, the terminal must be located not less than 2.3 metres from the structure. It must also terminate not less than 600mm above an imaginary line drawn between the outer edge of the extension, or 10 metres, (A), which ever the longer, and the edge of the higher roof, including any roof of an adjacent but separate building.

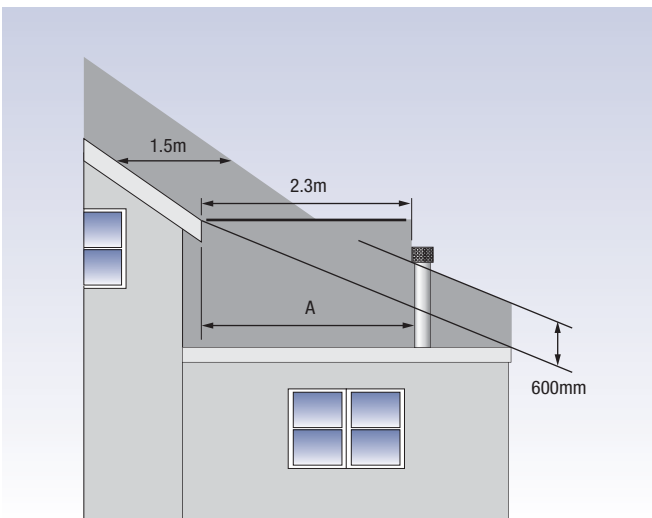

The flue shall terminate outside the dark shaded zone.

Termination through an extension roof adjacent to a taller flat roof building

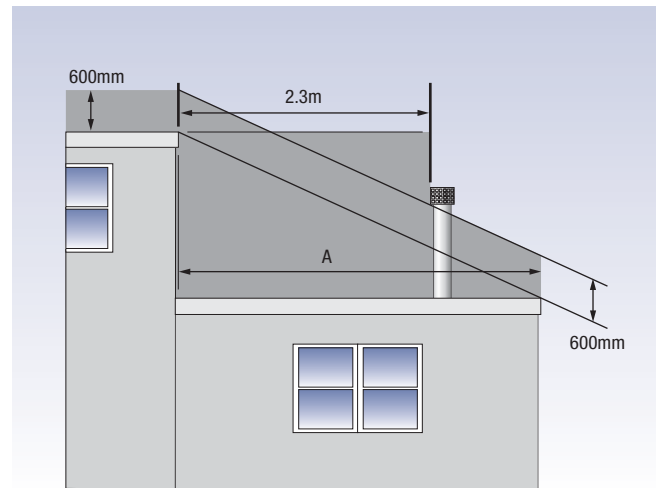

The flue shall terminate outside the dark shaded zone.

Termination above a pitched roof with structures for gas appliances

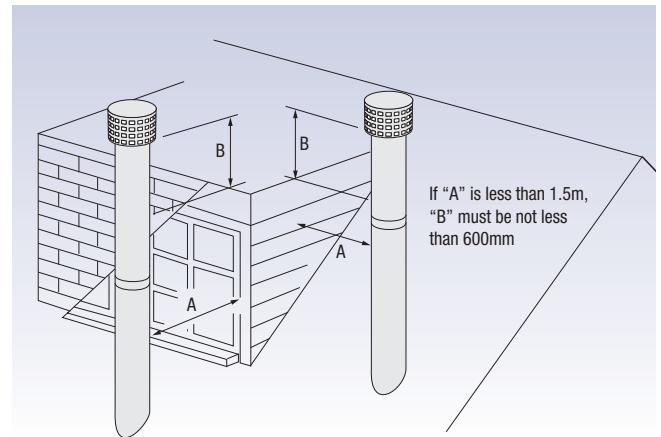

Terminals on flues serving gas-fired appliances adjacent to windows or openings on pitched and flat roofs

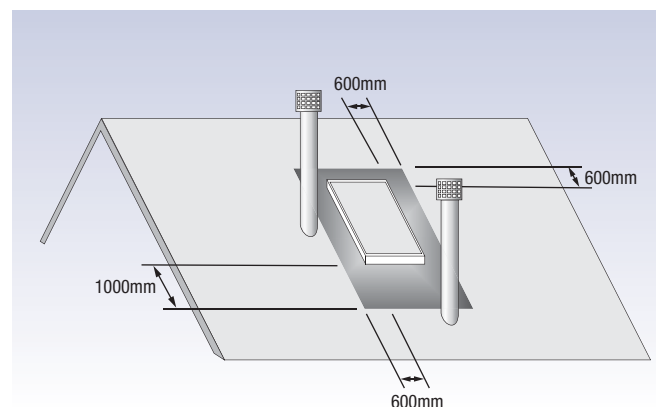

The chimney should not penetrate the dark shaded area.

Although we manufacture an extensive range of components, SFL understands that there are times when a standard component will simply not work for the intended installation. Being a UK manufacturer, we are ideally placed to manufacture bespoke components in a timely and competitive manor. Please photocopy and complete the required dimensions for the required special component and fax / scan and email your requirements to SFL, who will be happy to offer a quotation and lead time.

Appliance Adaptors

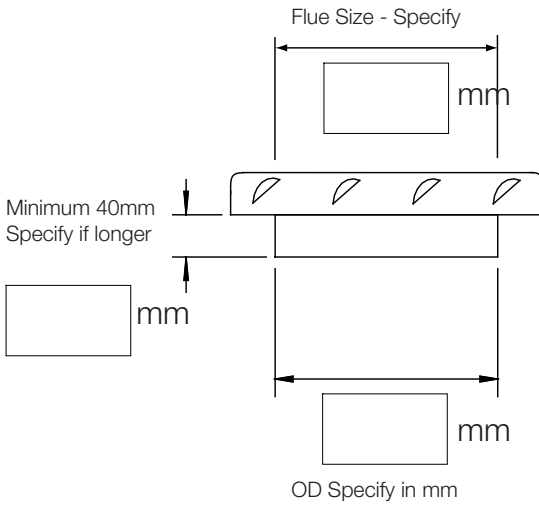

Elbows

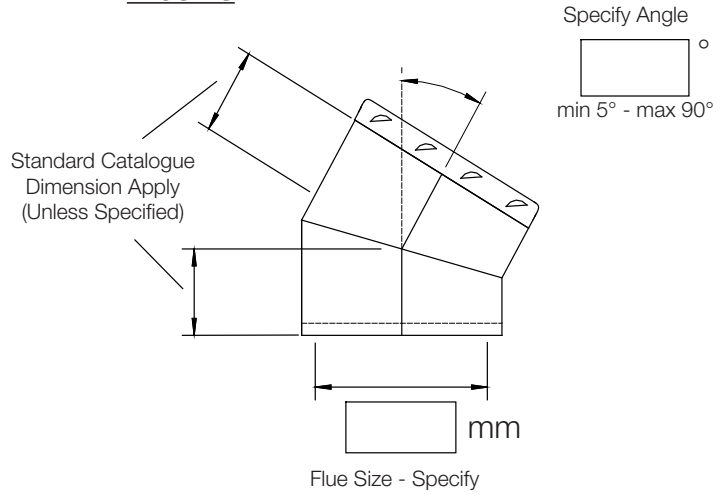

Standard & Reducing Tees

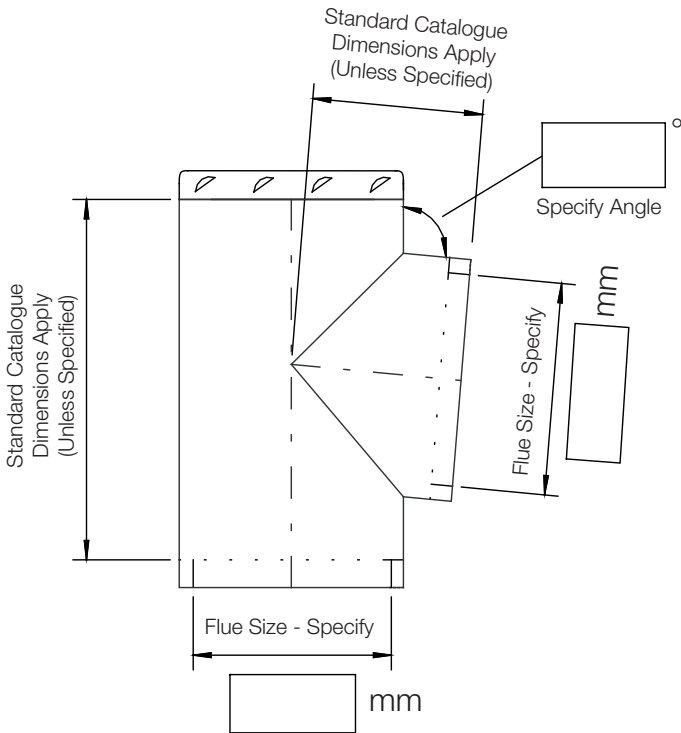

For Standard 90° & 95° Reducing Tees Please Refer To Page 9

Customer Name
Customer Address
Telephone Number
Email Address
Comments

Other great products from SFL



NOVA COMMERCIAL

The Nova Commercial product extends the Nova SM range into the commercial markets covering sizes from 400mm to 600mm internal diameter. Like the Nova SM product, the Nova Commercial range offers a truly multi-functional high quality product capable of serving both conventional and condensing applications. Suitable for negative draught operation up to 450°C, while offering pressure and condensate resistance up to 200Pa at 140°C by using seals.

With its installer friendly twist lock jointing system, Nova Commercial is both fast to install while offering a very strong and rigid joint design allowing a free standing unsupported height of up to 2.5 metres above the last support, without the need for any additional structural components.



Europa

The Europa product is ideal for the most stringent industrial applications offering a high temperature and positive pressure capability. With its flanged design the Europa product is capable of withstanding positive pressures up to 15,000Pa at a maximum temperature of 740°C. This makes Europa ideal for engine exhausts for use on standby electrical generators and CHP units. Europa is also extensively used for off shore applications and has been approved by Lloyds Registry for A-0, A-60 & H-60 applications, with the advantage that no on site welding is required for installation. With its 4 hour fire rating to BS 476: Part 24, Europa is also ideally suited for fire rated applications including kitchen extract systems, cable conduits and particle extraction systems. The Europa system is available from 100mm to 1200mm internal diameter and is available in a range of material specifications and insulation thicknesses.



Supra

Supra is a single wall chimney system designed for use on the latest high efficiency condensing appliances and is manufactured from a high grade corrosion resistant 316L stainless steel. Suitable for positive pressure applications up to 200Pa at a maximum flue gas temperature of 200°C where condensate resistance is required. Supra covers an internal diameter range from 80mm to 350mm and is supplied complete with factory fitted and bonded seals for ease and speed of installation.

Supra is also available in 1.0mm 316L material specification, covering internal diameters from 150mm to 600mm. This specification is supplied without seals and is ideal for re-lining applications. Seals can be retro fitted to the product where pressure and condensate resistance are required.



As SFL are a UK based company, we are ideally placed to offer rapid manufacture of special components, whether you require a multi-inlet header or a special angled tee, we can help.

The information contained in this brochure was accurate at the date of publishing. However the company reserves the right to introduce at any time modifications and changes of details as may be necessary. To avoid any misunderstanding, interested parties should contact the company to confirm whether any material alterations have been made since the date of this brochure.



UK Sales and Customer & Export Services
 SF Ltd, Pottington Business Park, Barnstaple, Devon EX31 1LZ
 Tel: 01271 326633 Fax: 01271 334303 www.sflchimneys.com Email: info@sflchimneys.com

